

Limited Lifetime Warranty

Valterra Products, LLC warrants our faucets against defects in material or workmanship for the life of your faucet, ordinary wear and tear excluded. Should any faucet, part or parts thereof prove defective, contact Valterra Products, LLC at 800-806-6159 for repair assistance or return authorization. Repair or replacement will be made without charge. Liability for consequential damages under any and all warranties are excluded to the extent such exclusion is permitted by law. Some states do not allow exclusion or limitation and exclusion may not apply to you. This warranty gives you specific legal rights, and you may also have other rights with vary from state to state.

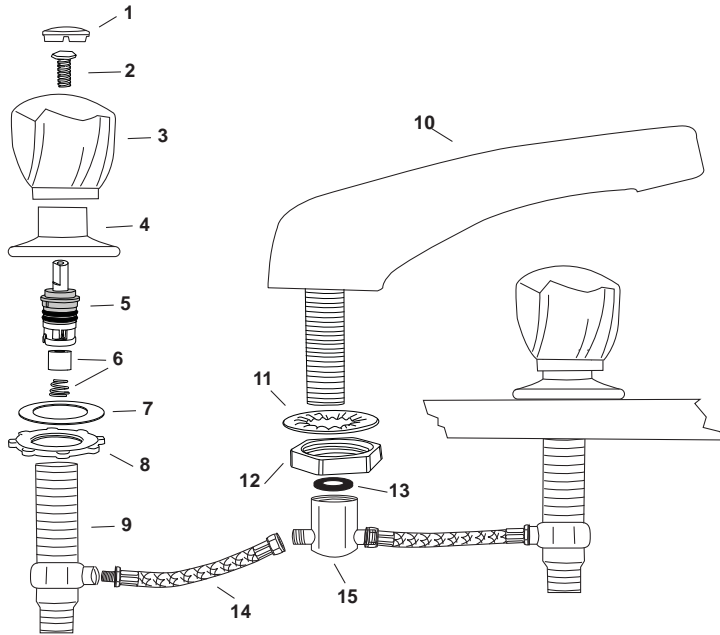

No.	NAME
1	HANDLE BUTTON
2	HANDLE SCREW
3	HANDLE
4	FLANGE
5	STEM & BONNET
6	SEAT SPRING & WASHER
7	FLAT VALVE WASHER
8	LOCKNUT

No.	NAME
9	VALVE
10	SPOUT
11	CROW'S FOOT WASHER
12	SPOUT NUT
13	BLACK RUBBER WASHER
14	FLEXIBLE HOSE
15	SPOUT TEE



Garden Tub Faucet

NOTE: Actual parts for your faucet may not look like those shown here. This illustration is for the purpose of identifying the name and placement of parts.

*Asterisked parts are not standard on all models.

Valterra Products, LLC
 Mission Hills, CA 91346
 1.800.806.6159
 www.valterra.com

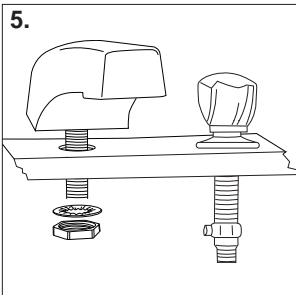
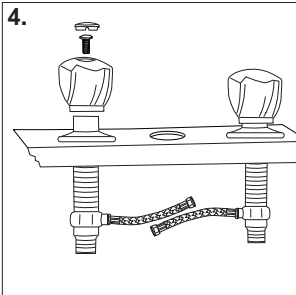
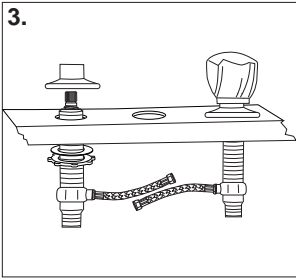
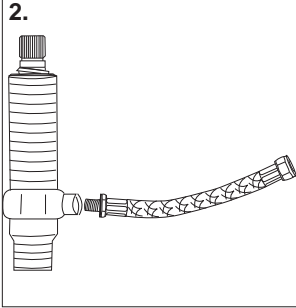
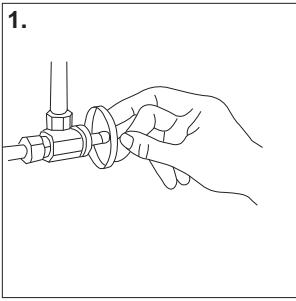

INSTALLATION:

1. SHUT OFF SUPPLY

Shut off hot and cold water supply lines. Clear Sink ledge of all debris.

2. CONNECT HOSES

Wrap end valves with teflon tape. Connect flexible hoses to end valves. Wrench tighten.

3. MOUNT SHANKS

- Thread locknuts onto end valves and add flat locknut washers.
- Insert a shank from under the ledge. Attach a flange to secure it. Adjust the flange to the desired height for the handle. Make sure the hose inlet is facing the center and tighten the locknut under the ledge. Tighten locknuts. Repeat to install the 2nd shank.

4. INSTALL HANDLES

Install handles and secure with handle screws. Snap in hot and cold buttons.

5. INSTALL SPOUT

Remove the backing from the spout gasket, slide it over the spout shank sticky side up and secure it to the bottom of the spout. Insert spout through hole in mounting surface. Slide crow foot washer onto shank. Screw on metal lock nut. Wrench tighten after aligning the spout.

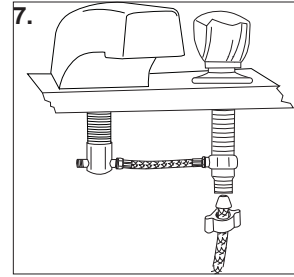
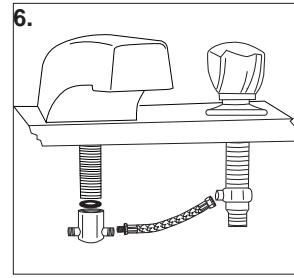

6. CONNECT FLEX HOSES

Place small black rubber washer into plastic tee. Screw tee onto spout shank. Connect flexible hoses to the tee, finger tighten. The end valves may have to be turned to align hoses onto the tee.

7. ATTACH WATER SUPPLY

Attach water supply lines to end valves.

8. FLUSH LINES

Flush lines by running the hot and cold sides in the full open position. Check for leaks.

OPERATING INSTRUCTIONS

KNOB HANDLE MODELS

Rotating the knob handle counter clockwise causes water to flow out the aerator. The degree of knob opening determines the volume of water flow. Returning the knob handles to their original position stops the flow of water.

LEVER HANDLE MODELS

Rotating the hot side lever handle counter clockwise or the cold side lever handle clockwise causes water to flow out the aerator. Returning the lever handles to their original position stops the flow of water.

SIDE SPRAY MODELS

To spray down the bowls or wash vegetables, pull spray head from holder and depress the lever to divert water from the spout to the spray head. Release the lever to return water to the spout. Return spray head to holder.

CAUTIONS:

All plastic connections should be hand tightened. **DO NOT USE TOOLS.** No sealant of any kind should be used between the tailpiece nut and the faucet shank.

HELPFUL HINTS

Be especially careful when screwing threaded connections together. Do not tighten any connection if the parts are not threading evenly. Unscrew the parts and start over.

CLEANING TIPS

The finish on your Phoenix faucet is designed to retain its beautiful sheen for years. To maintain the original look of the finish, we recommend the use of mild soap and water to clean the faucet. **THE USE OF ABRASIVE CLEANERS MAY SCRATCH THE FINISH.**