

### Limited Lifetime Warranty

Valterra Products, LLC warrants our faucets against defects in material or workmanship for the life of your faucet, ordinary wear and tear excluded. Should any faucet, part or parts thereof prove defective, contact Valterra Products, LLC at 800-806-6159 for repair assistance or return authorization. Repair or replacement will be made without charge. Liability for consequential damages under any and all warranties are excluded to the extent such exclusion is permitted by law. Some states do not allow exclusion or limitation and exclusion may not apply to you. This warranty gives you specific legal rights, and you may also have other rights with vary from state to state.

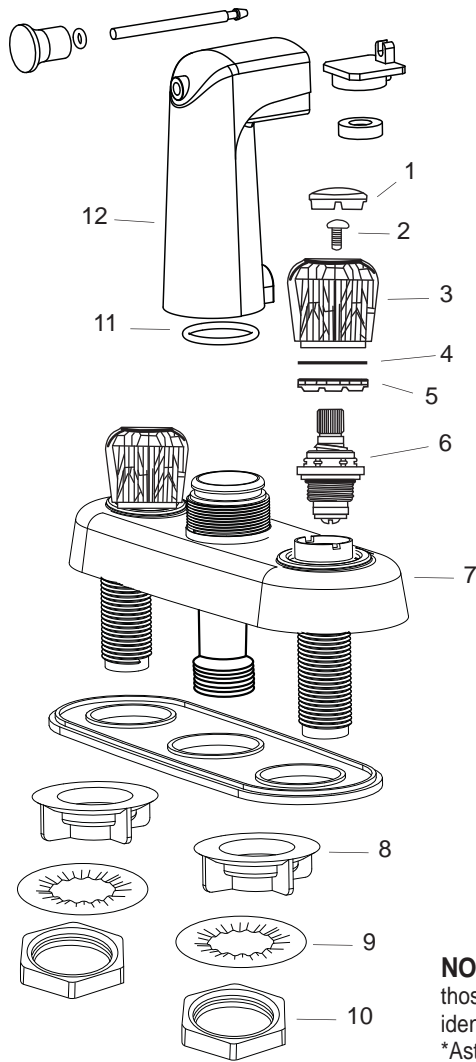

*Making Water Work Beautifully*



No.	NAME
1*	HANDLE BUTTON
2*	HANDLE SCREW
3*	HANDLE
4	BONNET WASHER
5	BONNET LOCKNUT
6*	STEM
7	SHIELD
8	LOCKNUT (PLASTIC SHANKS)
9	LOCKNUT WASHER (BRASS SHANKS)
10	LOCKNUT (BRASS SHANKS)
11	SPOUT O-RING
12	SPOUT ASSEMBLY



**NOTE:** Actual parts for your faucet may not look like those shown here. This illustration is for the purpose of identifying the name and placement of parts.  
 \*Asterisked parts are not standard on all models.  
 For additional information call us at 1.800.222.6041 toll free or visit us online at phoenixfaucets.com

## Two Handle Tub Shower Diverter

Valterra Products, LLC  
 Mission Hills, CA 91346  
 1.800.806.6159  
 www.valterra.com

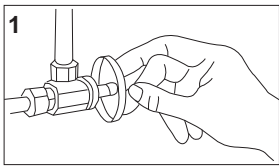

### 1. SHUT OFF SUPPLY

Shut off hot and cold water supply lines. Clear area of all debris.

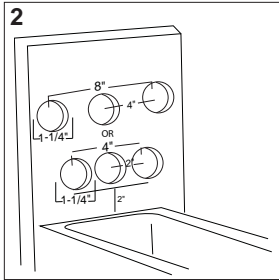

### 2. DRILL HOLES

Drill (3) 1-1/4" diameter holes spaced at 4" or 2" centers (depending on your valve size) in the shower wall surround.

**NOTE:** The outlet of the tub spout **MUST** be installed a **MINIMUM** of 2" above the flood rim of the tub.

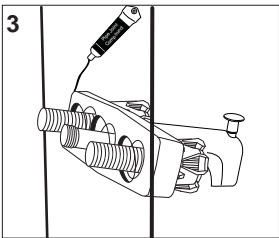

### 3. POSITION UNIT

Spread a small amount of tub and tile caulk on the surface of the bottom plate facing the wall. Position faucet through holes of wall. Assemble washer and locknuts.

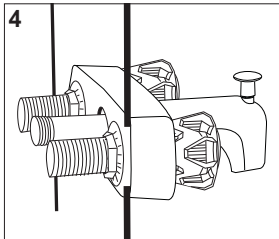

### 4. TIGHTEN LOCKNUTS

Align faucet from back side of mounting surface and secure by hand tightening locknuts. **THE BOTTOM PLATE MUST BE USED.**

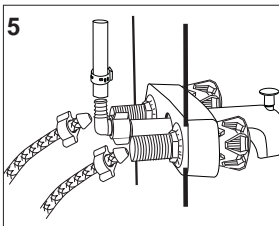

### 5. CONNECT WATER SUPPLY

Connect water supply: Hot water to the left and cold water to the right. Connect the shower tubing to the shower outlet. Make sure that the end of your existing supply line is straight and will touch the chamfer on the inside of the threaded shank. Screw the tailpiece nut onto the faucet shank. Hand tighten.

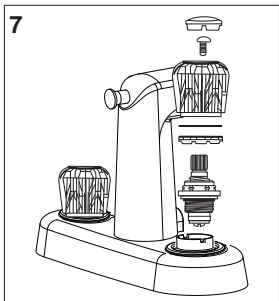

### 7. TROUBLESHOOTING

If the faucet develops a leak, it may be the result of debris in the water line which is preventing a good seal. Turn the faucet full on and off several times to flush out any material that may be lodged in the faucet. If the problem persists, follow these steps: Turn off the water supply. Open the faucet to relieve any line pressure.

Unsnap the Hot or Cold index button on the handle. Remove the handle screw using a phillips screwdriver.

Lift the handle off. Remove the bonnet lock and washer with a small screw driver.

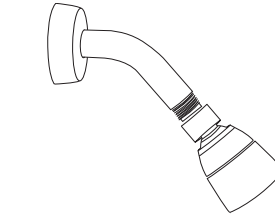
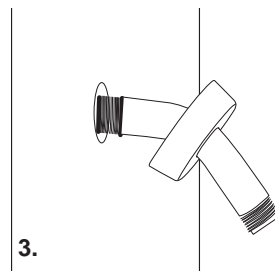
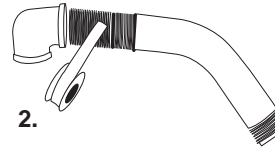

To remove the stem and bonnet, make sure it is in the full on position and, using a 3/4" deep socket turn the bonnet counter clockwise. Remove debris.

Replace all components in reverse order.

Turn water on and check for leaks.

1. Install Shower Head Assembly (not included with all models) Install 1/2" shower supply line (not included) to center connection on valve assembly and to a 1/2" elbow (not included with plastic models) at desired shower height.

2. Attach shower arm

Wrap shower arm end with 2 right hand wraps of teflon tape and screw shower arm into elbow at the shower supply line.

3. Attach Flange and Shower Head

Slide flange over the long end of the shower arm. Screw onto exposed threads at the top of the shower arm. Screw shower head onto the other end of the shower arm.

### OPERATING INSTRUCTIONS

#### Knob Handles:

Rotating the hot side knob handle counter clockwise, and likewise rotating the cold side knob handle counter clockwise, opens the cartridge and causes water to flow out the center shower outlet. The degree of handle opening determines the volume of water flow. Returning the lever handles to their original position stops the water flow.

#### Lever Handles:

Rotating the hot side lever handle counter clockwise, and likewise rotating the cold side lever handle clockwise, opens the cartridge and causes water to flow out the center shower outlet. The degree of handle opening determines the volume of water flow. Returning the lever handles to their original position stops the water flow.

### CLEANING TIPS

The finish on your Phoenix faucet is designed to retain its beautiful sheen for years. To maintain the original look of the finish, a little care and caution should be used. We recommend the use of mild soap and water to clean the faucet. **THE USE OF ABRASIVE CLEANERS MAY SCRATCH THE FINISH.**

### HELPFUL HINTS

Be especially careful when screwing threaded connections together. Do not tighten any connection if the parts are not threading evenly. Unscrew the parts and start over. Unscrew the nut until a click is heard. Then screw the nut on clockwise.

### CAUTIONS:

- All plastic connections should be hand tightened. **DO NOT USE TOOLS.**
- No sealant of any kind should be used between the tailpiece nut and the faucet shank.